



Beschreibung: Eine breite Palette mechanischer Fittings für den Transport von Wasser, gasförmigen Brennstoffen, Druckluft, chemischen Lösungen und Schlämmen unter Hochdruck.

Sortiment: Metrische Serie PN16, 16 Bar: von Ø 16 mm bis Ø 110 mm
 16 Bar bei 20°C für Klemmfittings von Ø 16 mm bis Ø 63 mm
 12,5 Bar bei 20°C für Klemmfittings von Ø 75 mm bis Ø 110 mm
 Metrische Serie PN10, 10 Bar: von Ø 20 mm bis Ø 63 mm
 Push Fit Serie, 16 Bar: von Ø 20 mm - Ø 25 mm & Ø 32 mm
 ZeeFlex Serie, 6 Bar: von Ø 50 mm & Ø 63 mm
 Lock Serie, 6 Bar: von Ø 16 mm bis Ø 32 mm

Der Betriebsdruck ist gemäß nachstehender Abbildung (Figur 1) einzustellen, wenn die Fittings bei höheren Temperaturen verwendet werden sollen.

Figur 1

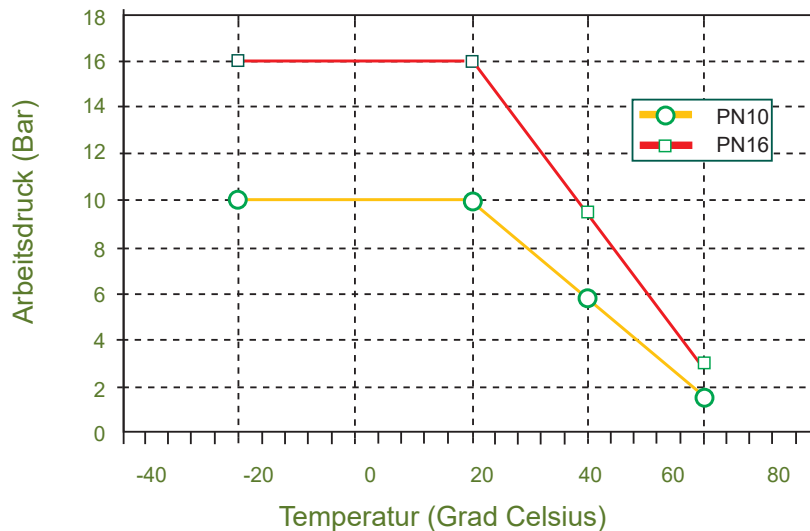

Die PN16 Serie ist gemäß maßgeblicher Normen geprüft und zugelassen:



Materialien: Gehäuse, Kappe, Einsatz: Polypropylene copolymer PP-B
 Polyvinyl Chloride PVC (ZeeFlex)
 Spaltring (Split Ring): Polyacetal
 O-Ring: Elastomergummi NBR70
 Elastomergummi EPDM (ZeeFlex)
 Verstärkungsring: Edelstahl

- ☛ Diese Fittings sind für den Einsatz in der Trinkwasserversorgung geeignet.
- ☛ Diese Fittings von Elysee haben eine sehr gute chemische Beständigkeit und eignen sich auch für den Kontakt mit Sonneneinstrahlung.

Für weitere Informationen erhalten Sie unsere technischen Datenblätter auf Anfrage:
info@elysee-rohrsysteme.com



Kupplung Adaptor	Klemm x AG compression x male			
Art.-Nr. Art.-No.	Dimension Dimension	Gewicht Weight	VPE PU	UVPE Bag
380 0016 10	16 mm x 3/8"	33	750	25
380 0016 01	16 mm x 1/2"	34	750	25
380 0016 02	16 mm x 3/4"	35	750	25
380 0020 01	20 mm x 1/2"	56	500	25
380 0020 02	20 mm x 3/4"	57	500	25
380 0020 03	20 mm x 1"	62	450	25
380 0025 01	25 mm x 1/2"	67	360	20
380 0025 02	25 mm x 3/4"	68	320	20
380 0025 03	25 mm x 1"	72	320	20
380 0032 01	32 mm x 1/2"	105	180	10
380 0032 02	32 mm x 3/4"	103	180	10
380 0032 03	32 mm x 1"	107	180	10
380 0032 04	32 mm x 1 1/4"	113	180	10
380 0032 05	32 mm x 1 1/2"	117	150	10
380 0040 03	40 mm x 1"	176	100	1
380 0040 04	40 mm x 1 1/4"	179	100	1
380 0040 05	40 mm x 1 1/2"	199	100	1
380 0040 06	40 mm x 2"	194	100	1
380 0050 03	50 mm x 1"	265	80	1
380 0050 04	50 mm x 1 1/4"	269	80	1
380 0050 05	50 mm x 1 1/2"	268	80	1
380 0050 06	50 mm x 2"	274	70	1
380 0063 05	63 mm x 1 1/2"	402	45	1
380 0063 06	63 mm x 2"	409	45	1
380 0063 07	63 mm x 2 1/2"	407	40	1
380 0075 06	75 mm x 2"	677	26	1
380 0075 07	75 mm x 2 1/2"	687	26	1
380 0075 08	75 mm x 3"	693	26	1
380 0090 06	90 mm x 2"	996	16	1
380 0090 07	90 mm x 2 1/2"	1030	16	1
380 0090 08	90 mm x 3"	1048	16	1
380 0090 09	90 mm x 4"	1070	16	1
380 0110 06	110 mm x 2"	1142	8	1
380 0110 08	110 mm x 3"	1126	8	1
380 0110 09	110 mm x 4"	1168	8	1

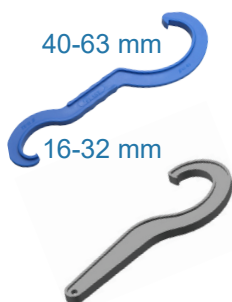

Montageschlüssel Cap wrench				
Art.-Nr. Art.-No.	Dimension Dimension	Gewicht Weight	VPE PU	UVPE Bag
380 000 001	16 - 63 mm für PP Verschraubungen	150	1	1
814 000 000	63 - 110 mm aus Aluminium	85	5	1



Kupplung Adaptor		Klemm x IG compression x female			
Art.-Nr. Art.-No.	Dimension Dimension	Gewicht Weight	VPE PU	UVPE Bag	
380A 016 10	16 mm x 3/8"	33	750	25	
380A 016 01	16 mm x 1/2"	40	750	25	
380A 016 02	16 mm x 3/4"	36	750	25	
380A 020 10	20 mm x 3/8"	47	500	25	
380A 020 01	20 mm x 1/2"	54	500	25	
380A 020 02	20 mm x 3/4"	51	500	25	
380A 025 01	25 mm x 1/2"	69	360	20	
380A 025 02	25 mm x 3/4"	66	360	20	
380A 025 03	25 mm x 1"	60	320	20	
380A 032 01	32 mm x 1/2"	115	220	10	
380A 032 02	32 mm x 3/4"	109	220	10	
380A 032 03	32 mm x 1"	103	220	10	
380A 032 04	32 mm x 1 1/4"	119	150	10	
380A 032 05	32 mm x 1 1/2"	133	150	10	
380A 040 03	40 mm x 1"	181	100	1	
380A 040 04	40 mm x 1 1/4"	186	100	1	
380A 040 05	40 mm x 1 1/2"	199	100	1	
380A 050 04	50 mm x 1 1/4"	253	65	1	
380A 050 05	50 mm x 1 1/2"	262	65	1	
380A 050 06	50 mm x 2"	401	65	1	
380A 063 05	63 mm x 1 1/2"	379	45	1	
380A 063 06	63 mm x 2"	313	45	1	
380A 063 07	63 mm x 2 1/2"	402	40	1	
380A 075 06	75 mm x 2"	665	26	1	
380A 075 07	75 mm x 2 1/2"	691	26	1	
380A 075 08	75 mm x 3"	695	26	1	
380A 090 07	90 mm x 2 1/2"	710	16	1	
380A 090 08	90 mm x 3"	897	16	1	
380A 090 09	90 mm x 4"	905	16	1	
380A 110 08	110 mm x 3"	1150	8	1	
380A 110 09	110 mm x 4"	1186	8	1	

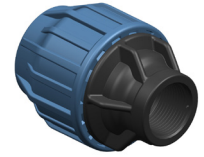

Kupplung mit Flansch Komplettsset - Schrauben, Muttern und Dichtung

Flanged adaptor complete set - bolts, nuts and gasket

Art.-Nr. Art.-No.	Dimension Dimension	DN DN	[Zoll] [inches]	Lochkreis bolt circle	Schrauben Bolts	Gewicht Weight	VPE PU	UVPE Bag
380D 05005	50 mm x 40	40	[1 1/2"]	110 mm	4	1340	15	1
380D 05006	50 mm x 50	50	[2"]	125 mm	4	1580	20	1
380D 06306	63 mm x 50	50	[2"]	125 mm	4	1800	15	1
380D 06307	63 mm x 65	65	[2 1/2"]	145 mm	4	2160	15	1
380D 07507	75 mm x 65	65	[2 1/2"]	145 mm	4	2260	10	1
380D 07508	75 mm x 80	80	[3"]	160 mm	8	3275	10	1
380D 09008	90 mm x 80	80	[3"]	160 mm	8	3500	7	1
380D 09009	90 mm x 100	100	[4"]	180 mm	8	3950	6	1
380D 11009	110 mm x 100	100	[4"]	180 mm	8	4500	4	1



Fester Sitz der Dichtung, auch während der Installation, aufgrund des neuen Designs.
Fixed gasket connection with adaptor, also during installation, due to novel design.



Kupplung <i>Coupling</i>		Klemm x Klemm <i>compression x compression</i>			
Art.-Nr. Art.-No.	Dimension Dimension	Gewicht Weight	VPE PU	UVPE Bag	
381 016 016	16 mm x 16 mm	54	525	25	
381 020 020	20 mm x 20 mm	89	315	15	
381 025 025	25 mm x 25 mm	104	225	15	
381 032 032	32 mm x 32 mm	172	120	10	
381 040 040	40 mm x 40 mm	307	72	1	
381 050 050	50 mm x 50 mm	437	44	1	
381 063 063	63 mm x 63 mm	625	30	1	
381 075 075	75 mm x 75 mm	1158	16	1	
381 090 090	90 mm x 90 mm	1691	10	1	
381 110 110	110 mm x 110 mm	1983	5	1	



Reduzierkupplung <i>Reducing Coupling</i>		Klemm x Klemm <i>compression x compression</i>			
Art.-Nr. Art.-No.	Dimension Dimension	Gewicht Weight	VPE PU	UVPE Bag	
381A 020 16	20 mm x 16 mm	71	360	20	
381A 025 16	25 mm x 16 mm	85	300	20	
381A 025 20	25 mm x 20 mm	98	255	15	
381A 032 20	32 mm x 20 mm	138	180	10	
381A 032 25	32 mm x 25 mm	142	150	10	
381A 040 25	40 mm x 25 mm	207	100	1	
381A 040 32	40 mm x 32 mm	232	85	1	
381A 050 32	50 mm x 32 mm	307	60	1	
381A 050 40	50 mm x 40 mm	367	60	1	
381A 063 32	63 mm x 32 mm	440	40	1	
381A 063 40	63 mm x 40 mm	510	40	1	NEW
381A 063 50	63 mm x 50 mm	523	30	1	
381A 075 63	75 mm x 63 mm	882	18	1	
381A 090 63	90 mm x 63 mm	1384	12	1	
381A 090 75	90 mm x 75 mm	1400	12	1	
381A 110 75	110 mm x 75 mm	1763	8	1	
381A 110 90	110 mm x 90 mm	1900	8	1	



Endkappe <i>End plug</i>		Klemm <i>compression</i>			
Art.-Nr. Art.-No.	Dimension Dimension	Gewicht Weight	VPE PU	UVPE Bag	
380B 000 16	16 mm	32	900	25	
380B 000 20	20 mm	55	500	20	
380B 000 25	25 mm	66	340	20	
380B 000 32	32 mm	104	220	10	
380B 000 40	40 mm	171	125	1	
380B 000 50	50 mm	266	80	1	
380B 000 63	63 mm	402	45	1	
380B 000 75	75 mm	685	26	1	
380B 000 90	90 mm	1026	16	1	
380B 00 110	110 mm	1120	10	1	



Reparatur Kupplung		Klemm x Klemm			
Repair Coupling		compression x compression		NEW	
Art.-Nr. Art.-No.	Dimension Dimension	Gewicht Weight	VPE PU	UVPE Bag	
381B 000 25	25 mm x 25 mm	99	160	10	
381B 000 32	32 mm x 32 mm	200	100	10	
381B 000 40	40 mm x 40 mm	345	60	1	
381B 000 50	50 mm x 50 mm	505	35	1	
381B 000 63	63 mm x 63 mm	810	20	1	
381B 000 75	75 mm x 75 mm	1158	16	1	
381B 000 90	90 mm x 90 mm	1691	10	1	
381B 00 110	110 mm x 110 mm	1983	5	1	



25-63 mm



75-110 mm

90° Winkel		Klemm x Klemm			
90° Elbow		compression x compression			
Art.-Nr. Art.-No.	Dimension Dimension	Gewicht Weight	VPE PU	UVPE Bag	
382 016 016	16 mm x 16 mm	56	450	25	
382 020 020	20 mm x 20 mm	92	240	20	
382 025 025	25 mm x 25 mm	112	195	15	
382 032 032	32 mm x 32 mm	181	100	1	
382 040 040	40 mm x 40 mm	339	60	1	
382 050 050	50 mm x 50 mm	484	36	1	
382 063 063	63 mm x 63 mm	701	24	1	
382 075 075	75 mm x 75 mm	1230	12	1	
382 090 090	90 mm x 90 mm	2019	8	1	
382 110 110	110 mm x 110 mm	2269	4	1	



90° Winkel		Klemm x AG			
90° Elbow		compression x male			
Art.-Nr. Art.-No.	Dimension Dimension	Gewicht Weight	VPE PU	UVPE Bag	
382A 016 01	16 mm x 1/2"	37	600	25	
382A 016 02	16 mm x 3/4"	37	600	25	
382A 020 01	20 mm x 1/2"	52	425	25	
382A 020 02	20 mm x 3/4"	62	425	25	
382A 025 01	25 mm x 1/2"	75	360	20	
382A 025 02	25 mm x 3/4"	76	320	20	
382A 025 03	25 mm x 1"	79	300	20	
382A 032 02	32 mm x 3/4"	122	180	10	
382A 032 03	32 mm x 1"	119	180	10	
382A 040 04	40 mm x 1 1/4"	237	90	1	
382A 040 05	40 mm x 1 1/2"	247	90	1	
382A 050 05	50 mm x 1 1/2"	345	60	1	
382A 050 06	50 mm x 2"	355	60	1	
382A 063 06	63 mm x 2"	525	30	1	
382A 063 07	63 mm x 2 1/2"	559	30	1	
382A 075 07	75 mm x 2 1/2"	871	15	1	
382A 075 08	75 mm x 3"	835	15	1	
382A 090 08	90 mm x 3"	1180	10	1	
382A 110 09	110 mm x 4"	1684	6	1	





90° Winkel 90° Elbow	Klemm x IG compression x female			
Art.-Nr. Art.-No.	Dimension Dimension	Gewicht Weight	VPE PU	UVPE Bag
382B 020 01	20 mm x 1/2 "	68	375	25
382B 020 02	20 mm x 3/4 "	65	375	25
382B 025 01	25 mm x 1/2 "	84	260	20
382B 025 02	25 mm x 3/4 "	79	260	20
382B 025 03	25 mm x 1 "	83	260	20
382B 032 02	32 mm x 3/4 "	122	180	10
382B 032 03	32 mm x 1 "	117	180	10
382B 040 04	40 mm x 1 1/4 "	229	75	1
382B 040 05	40 mm x 1 1/2 "	239	75	1
382B 050 05	50 mm x 1 1/2 "	325	55	1
382B 050 06	50 mm x 2 "	312	55	1
382B 063 06	63 mm x 2 "	505	30	1
382B 063 07	63 mm x 2 1/2 "	487	30	1
382B 075 07	75 mm x 2 1/2 "	945	15	1
382B 075 08	75 mm x 3 "	879	15	1
382B 090 08	90 mm x 3 "	1218	10	1
382B 110 09	110 mm x 4 "	1620	6	1



Winkel Elbow	Klemm x IG compression x female	mit Wandscheibe wall mounted		
Art.-Nr. Art.-No.	Dimension Dimension	Gewicht Weight	VPE PU	UVPE Bag
382D 020 01	20 mm x 1/2 "	72	240	10
382D 025 02	25 mm x 3/4 "	96	140	10



T-Stück Tee	Klemm x Klemm x Klemm compression x compression x compression			
Art.-Nr. Art.-No.	Dimension Dimension	Gewicht Weight	VPE PU	UVPE Bag
384 016 016	16 mm x 16 mm x 16 mm	83	260	20
384 020 020	20 mm x 20 mm x 20 mm	138	150	15
384 025 025	25 mm x 25 mm x 25 mm	165	110	10
384 032 032	32 mm x 32 mm x 32 mm	273	70	1
384 040 040	40 mm x 40 mm x 40 mm	502	40	1
384 050 050	50 mm x 50 mm x 50 mm	701	25	1
384 063 063	63 mm x 63 mm x 63 mm	960	15	1
384 075 075	75 mm x 75 mm x 75 mm	1801	8	1
384 090 090	90 mm x 90 mm x 90 mm	2873	5	1
384 110 110	110 mm x 110 mm x 110 mm	3285	2	1



T-Stück		Klemm x AG x Klemm				
<i>Tee</i>		<i>compression x male x compression</i>				
Art.-Nr. <i>Art.-No.</i>	Dimension <i>Dimension</i>	Gewicht <i>Weight</i>	VPE <i>PU</i>	UVPE <i>Bag</i>		
383A 016 01	16 mm x ½ " x 16 mm	63	320	20		
383A 016 02	16 mm x ¾ " x 16 mm	62	320	20		
383A 020 01	20 mm x ½ " x 20 mm	104	180	15		
383A 020 02	20 mm x ¾ " x 20 mm	104	180	15		
383A 020 03	20 mm x 1 " x 20 mm	113	160	10		
383A 025 01	25 mm x ½ " x 25 mm	129	150	15		
383A 025 02	25 mm x ¾ " x 25 mm	132	150	15		
383A 025 03	25 mm x 1 " x 25 mm	133	120	10		
383A 032 01	32 mm x ½ " x 32 mm	196	100	1		
383A 032 02	32 mm x ¾ " x 32 mm	206	100	1		
383A 032 03	32 mm x 1 " x 32 mm	204	85	1		
383A 040 03	40 mm x 1 " x 40 mm	367	50	1		
383A 040 04	40 mm x 1 ¼ " x 40 mm	368	50	1		
383A 040 05	40 mm x 1 ½ " x 40 mm	373	50	1		
383A 050 05	50 mm x 1 ½ " x 50 mm	528	30	1		
383A 050 06	50 mm x 2 " x 50 mm	538	35	1		
383A 063 06	63 mm x 2 " x 63 mm	717	20	1		
383A 075 06	75 mm x 2 " x 75 mm	1340	10	1		
383A 075 07	75 mm x 2 ½ " x 75 mm	1432	10	1		
383A 075 08	75 mm x 3 " x 75 mm	1416	10	1		
383A 090 08	90 mm x 3 " x 90 mm	2181	6	1		
383A 110 09	110 mm x 4 " x 110 mm	2683	4	1		



T-Stück		Klemm x IG x Klemm				
<i>Tee</i>		<i>compression x female x compression</i>				
Art.-Nr. <i>Art.-No.</i>	Dimension <i>Dimension</i>	Gewicht <i>Weight</i>	VPE <i>PU</i>	UVPE <i>Bag</i>		
383 0016 01	16 mm x ½ " x 16 mm	67	320	20		
383 0016 02	16 mm x ¾ " x 16 mm	64	320	20		
383 0020 01	20 mm x ½ " x 20 mm	103	225	15		
383 0020 02	20 mm x ¾ " x 20 mm	101	225	15		
383 0025 01	25 mm x ½ " x 25 mm	129	160	10		
383 0025 02	25 mm x ¾ " x 25 mm	126	160	10		
383 0025 03	25 mm x 1 " x 25 mm	131	160	10		
383 0032 02	32 mm x ¾ " x 32 mm	203	100	1		
383 0032 03	32 mm x 1 " x 32 mm	198	100	1		
383 0040 04	40 mm x 1 ¼ " x 40 mm	380	45	1		
383 0040 05	40 mm x 1 ½ " x 40 mm	387	45	1		
383 0050 05	50 mm x 1 ½ " x 50 mm	551	30	1		
383 0050 06	50 mm x 2 " x 50 mm	536	30	1		
383 0063 06	63 mm x 2 " x 63 mm	735	18	1		
383 0063 07	63 mm x 2 ½ " x 63 mm	739	18	1		
383 0075 06	75 mm x 2 " x 75 mm	1384	10	1		
383 0075 07	75 mm x 2 ½ " x 75 mm	1506	10	1		
383 0075 08	75 mm x 3 " x 75 mm	1416	10	1		
383 0090 08	90 mm x 3 " x 90 mm	2221	7	1		
383 0110 09	110 mm x 4 " x 110 mm	2643	4	1		



**Reduzier T-Stück Klemm x Klemm x Klemm***Reducing Tee compression x compression x compression*

Art.-Nr. Art.-No.	Dimension Dimension	Gewicht Weight	VPE PU	UVPE Bag
384A 020 16	20 mm x 16 mm x 20 mm	124	160	10
384A 025 20	25 mm x 20 mm x 25 mm	163	120	10
384A 032 25	32 mm x 25 mm x 32 mm	201	80	1
384A 040 32	40 mm x 32 mm x 40 mm	419	40	1
384A 050 40	50 mm x 40 mm x 50 mm	623	25	1
384A 063 25	63 mm x 25 mm x 63 mm	650	16	1
384A 063 32	63 mm x 32 mm x 63 mm	670	16	1
384A 063 40	63 mm x 40 mm x 63 mm	676	16	1
384A 063 50	63 mm x 50 mm x 63 mm	684	16	1
384A 075 63	75 mm x 63 mm x 75 mm	1613	8	1
384A 090 75	90 mm x 75 mm x 90 mm	2566	5	1
384A 110 90	110 mm x 90 mm x 110 mm	3183	2	1

NEW**Erweiterungs T-Stück Klemm x Klemm x Klemm***Increasing Tee compression x compression x compression***NEW**

Art.-Nr. Art.-No.	Dimension Dimension	Gewicht Weight	VPE PU	UVPE Bag
384B 020 25	20 mm x 25 mm x 20 mm	124	120	10
384B 025 32	25 mm x 32 mm x 25 mm	163	80	1

**Winkel für Pop-Up Klemm x IG seitlich x Klemm***Elbow for Pop-Up compression x female laterally x compression*

Art.-Nr. Art.-No.	Dimension Dimension	Gewicht Weight	VPE PU	UVPE Bag
382C 025 01	25 mm x 1/2" x 25 mm	108	160	10
382C 032 01	32 mm x 1/2" x 32 mm	192	100	10
382C 032 02	32 mm x 3/4" x 32 mm	192	100	10

Universal

Kupplung		Klemm x Klemm			NEW	
<i>Coupling</i>		<i>compression x compression</i>			PN 6	
Art.-Nr. <i>Art.-No.</i>	Dimension <i>Dimension</i>	Gewicht <i>Weight</i>	VPE <i>PU</i>	UVPE <i>Bag</i>		
321C 020 15	20 mm x 15 mm	56	400	20		
321C 025 15	25 mm x 15 mm	68	300	10		
321C 025 22	25 mm x 22 mm	73	260	10		
321C 032 22	32 mm x 22 mm	115	160	10		
321C 032 28	32 mm x 28 mm	129	150	10		

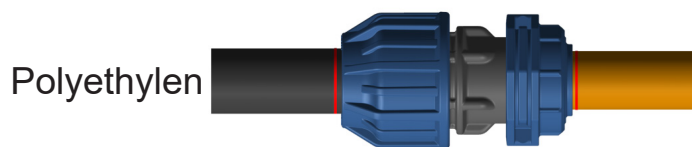

Polyethylen

- ✓ Kupfer / *Copper*
- ✓ Polybutylen / *Polybutylene*
- ✓ PEX / *PEX*

Global

Übergangskupplung		Klemm x Klemm			NEW	
<i>Transition Coupling</i>		<i>compression x compression</i>			PN 10	
Art.-Nr. <i>Art.-No.</i>	Dimension <i>Dimension</i>	Gewicht <i>Weight</i>	VPE <i>PU</i>	UVPE <i>Bag</i>		
321D 022 20	15 - 22 mm x 20 mm	181	80	1		
321D 022 25	15 - 22 mm x 25 mm	192	80	1		
321D 027 25	20 - 27 mm x 25 mm	230	70	1		
321D 027 32	20 - 27 mm x 32 mm	261	55	1		
321D 034 25	27 - 34 mm x 25 mm	277	60	1		
321D 034 32	27 - 34 mm x 32 mm	308	40	1		

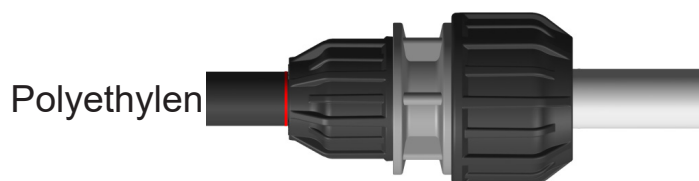

Polyethylen

- ✓ Kupfer / *Copper*
- ✓ Eisen verzinkt / *Iron galvanized*
- ✓ PVC / *PVC*
- ✓ Edelstahl / *Stainless steel*
- ✓ ABS / *ABS*

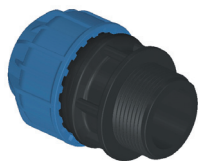

Kupplung		Klemm x AG		
<i>Adaptor</i>		<i>compression x male</i>		
Art.-Nr. <i>Art.-No.</i>	Dimension <i>Dimension</i>	Gewicht <i>Weight</i>	VPE <i>PU</i>	UVPE <i>Bag</i>
370 0020 01	20 mm x ½ "	33	600	20
370 0020 02	20 mm x ¾ "	35	600	20
370 0020 03	20 mm x 1 "	39	480	20
370 0025 01	25 mm x ½ "	49	340	20
370 0025 02	25 mm x ¾ "	50	340	20
370 0025 03	25 mm x 1 "	53	320	20
370 0032 01	32 mm x ½ "	112	200	20
370 0032 02	32 mm x ¾ "	114	200	20
370 0032 03	32 mm x 1 "	116	200	10
370 0032 04	32 mm x 1 ¼ "	118	200	10
370 0032 05	32 mm x 1 ½ "	118	180	10
370 0040 03	40 mm x 1 "	153	120	1
370 0040 04	40 mm x 1 ¼ "	155	120	1
370 0040 05	40 mm x 1 ½ "	159	120	1
370 0040 06	40 mm x 2 "	169	120	1
370 0050 03	50 mm x 1 "	182	100	1
370 0050 04	50 mm x 1 ¼ "	185	100	1
370 0050 05	50 mm x 1 ½ "	187	100	1
370 0050 06	50 mm x 2 "	213	90	1
370 0063 05	63 mm x 1 ½ "	320	50	1
370 0063 06	63 mm x 2 "	327	50	1
370 0063 07	63 mm x 2 ½ "	325	45	1

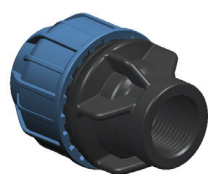

Kupplung		Klemm x IG		
<i>Adaptor</i>		<i>compression x female</i>		
Art.-Nr. <i>Art.-No.</i>	Dimension <i>Dimension</i>	Gewicht <i>Weight</i>	VPE <i>PU</i>	UVPE <i>Bag</i>
370A 020 01	20 mm x ½ "	32	500	20
370A 020 02	20 mm x ¾ "	35	500	20
370A 025 01	25 mm x ½ "	49	380	20
370A 025 02	25 mm x ¾ "	48	380	20
370A 025 03	25 mm x 1 "	55	380	20
370A 032 01	32 mm x ½ "	110	220	20
370A 032 02	32 mm x ¾ "	110	220	20
370A 032 03	32 mm x 1 "	112	220	20
370A 040 03	40 mm x 1 "	136	120	1
370A 040 04	40 mm x 1 ¼ "	142	120	1
370A 040 05	40 mm x 1 ½ "	144	120	1
370A 050 05	50 mm x 1 ½ "	168	80	1
370A 050 06	50 mm x 2 "	179	80	1
370A 063 05	63 mm x 1 ½ "	297	50	1
370A 063 06	63 mm x 2 "	231	50	1
370A 063 07	63 mm x 2 ½ "	320	45	1

Kupplung <i>Coupling</i>		Klemm x Klemm <i>compression x compression</i>			
Art.-Nr. <i>Art.-No.</i>	Dimension <i>Dimension</i>	Gewicht <i>Weight</i>	VPE <i>PU</i>	UVPE <i>Bag</i>	
371 020 020	20 mm x 20 mm	57	280	20	
371 025 025	25 mm x 25 mm	78	220	20	
371 032 032	32 mm x 32 mm	127	120	10	
371 040 040	40 mm x 40 mm	212	90	1	
371 050 050	50 mm x 50 mm	282	60	1	
371 063 063	63 mm x 63 mm	461	32	1	

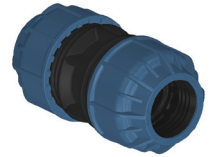

Reduzierkupplung <i>Reducing Coupling</i>		Klemm x Klemm <i>compression x compression</i>			
Art.-Nr. <i>Art.-No.</i>	Dimension <i>Dimension</i>	Gewicht <i>Weight</i>	VPE <i>PU</i>	UVPE <i>Bag</i>	
371A 025 20	25 mm x 20 mm	68	300	20	
371A 032 20	32 mm x 20 mm	98	200	20	
371A 032 25	32 mm x 25 mm	107	180	15	
371A 040 32	40 mm x 32 mm	260	95	1	
371A 050 40	50 mm x 40 mm	310	70	1	
371A 063 32	63 mm x 32 mm	358	35	1	
371A 063 50	63 mm x 50 mm	441	35	1	



Endkappe <i>End plug</i>		Klemm <i>compression</i>			
Art.-Nr. <i>Art.-No.</i>	Dimension <i>Dimension</i>	Gewicht <i>Weight</i>	VPE <i>PU</i>	UVPE <i>Bag</i>	
370B 000 20	20 mm	37	500	20	
370B 000 25	25 mm	49	360	20	
370B 000 32	32 mm	111	220	20	
370B 000 40	40 mm	135	150	1	
370B 000 50	50 mm	183	100	1	
370B 000 63	63 mm	320	50	1	



90° Winkel <i>90° Elbow</i>		Klemm x Klemm <i>compression x compression</i>			
Art.-Nr. <i>Art.-No.</i>	Dimension <i>Dimension</i>	Gewicht <i>Weight</i>	VPE <i>PU</i>	UVPE <i>Bag</i>	
372 020 020	20 mm x 20 mm	62	240	20	
372 025 025	25 mm x 25 mm	88	200	20	
372 032 032	32 mm x 32 mm	152	100	1	
372 040 040	40 mm x 40 mm	261	80	1	
372 050 050	50 mm x 50 mm	348	45	1	
372 063 063	63 mm x 63 mm	537	30	1	





90° Winkel		Klemm x AG			
<i>90° Elbow</i>		<i>compression x male</i>			
Art.-Nr. Art.-No.	Dimension Dimension	Gewicht Weight	VPE PU	UVPE Bag	
372A 020 01	20 mm x ½ "	43	500	20	
372A 020 02	20 mm x ¾ "	46	500	20	
372A 025 01	25 mm x ½ "	54	280	20	
372A 025 02	25 mm x ¾ "	59	280	20	
372A 025 03	25 mm x 1 "	66	240	20	
372A 032 02	32 mm x ¾ "	90	180	20	
372A 032 03	32 mm x 1 "	98	180	20	
372A 040 04	40 mm x 1 ¼ "	177	110	1	
372A 040 05	40 mm x 1 ½ "	171	110	1	
372A 050 05	50 mm x 1 ½ "	248	75	1	
372A 050 06	50 mm x 2 "	252	75	1	
372A 063 06	63 mm x 2 "	443	40	1	
372A 063 07	63 mm x 2 ½ "	477	40	1	



90° Winkel		Klemm x IG			
<i>90° Elbow</i>		<i>compression x female</i>			
Art.-Nr. Art.-No.	Dimension Dimension	Gewicht Weight	VPE PU	UVPE Bag	
372B 020 01	20 mm x ½ "	56	360	20	
372B 020 02	20 mm x ¾ "	57	360	20	
372B 025 01	25 mm x ½ "	77	320	20	
372B 025 02	25 mm x ¾ "	77	320	20	
372B 025 03	25 mm x 1 "	86	200	20	
372B 032 02	32 mm x ¾ "	113	170	10	
372B 032 03	32 mm x 1 "	108	170	10	
372B 040 04	40 mm x 1 ¼ "	177	90	1	
372B 040 05	40 mm x 1 ½ "	206	90	1	
372B 050 05	50 mm x 1 ½ "	254	70	1	
372B 050 06	50 mm x 2 "	279	70	1	
372B 063 06	63 mm x 2 "	423	40	1	
372B 063 07	63 mm x 2 ½ "	405	40	1	



T-Stück		Klemm x Klemm x Klemm			
<i>Tee</i>		<i>compression x compression x compression</i>			
Art.-Nr. Art.-No.	Dimension Dimension	Gewicht Weight	VPE PU	UVPE Bag	
374 020 020	20 mm x 20 mm x 20 mm	89	160	10	
374 025 025	25 mm x 25 mm x 25 mm	138	120	10	
374 032 032	32 mm x 32 mm x 32 mm	214	75	1	
374 040 040	40 mm x 40 mm x 40 mm	382	50	1	
374 050 050	50 mm x 50 mm x 50 mm	504	35	1	
374 063 063	63 mm x 63 mm x 63 mm	714	16	1	

T-Stück		Klemm x AG x Klemm				
<i>Tee</i>		<i>compression x male x compression</i>				
Art.-Nr. <i>Art.-No.</i>	Dimension <i>Dimension</i>	Gewicht <i>Weight</i>	VPE <i>PU</i>	UVPE <i>Bag</i>		
373A 020 01	20 mm x ½" x 20 mm	70	220	20		
373A 020 02	20 mm x ¾" x 20 mm	72	220	20		
373A 020 03	20 mm x 1" x 20 mm	80	200	20		
373A 025 01	25 mm x ½" x 25 mm	99	160	20		
373A 025 02	25 mm x ¾" x 25 mm	100	160	10		
373A 025 03	25 mm x 1" x 25 mm	104	160	10		
373A 032 01	32 mm x ½" x 32 mm	159	100	1		
373A 032 02	32 mm x ¾" x 32 mm	170	100	1		
373A 032 03	32 mm x 1" x 32 mm	167	100	1		
373A 040 03	40 mm x 1" x 40 mm	292	60	1		
373A 040 04	40 mm x 1 ¼" x 40 mm	70	60	1		
373A 040 05	40 mm x 1 ½" x 40 mm	72	60	1		
373A 050 05	50 mm x 1 ½" x 50 mm	80	40	1		
373A 050 06	50 mm x 2" x 50 mm	99	40	1		
373A 063 06	63 mm x 2" x 63 mm	553	25	1		



T-Stück		Klemm x IG x Klemm				
<i>Tee</i>		<i>compression x female x compression</i>				
Art.-Nr. <i>Art.-No.</i>	Dimension <i>Dimension</i>	Gewicht <i>Weight</i>	VPE <i>PU</i>	UVPE <i>Bag</i>		
373 0020 01	20 mm x ½" x 20 mm	76	220	20		
373 0020 02	20 mm x ¾" x 20 mm	76	220	20		
373 0025 01	25 mm x ½" x 25 mm	108	160	20		
373 0025 02	25 mm x ¾" x 25 mm	103	160	20		
373 0032 02	32 mm x ¾" x 32 mm	171	100	1		
373 0032 03	32 mm x 1" x 32 mm	163	100	1		
373 0040 04	40 mm x 1 ¼" x 40 mm	303	60	1		
373 0040 05	40 mm x 1 ½" x 40 mm	301	60	1		
373 0050 05	50 mm x 1 ½" x 50 mm	433	40	1		
373 0050 06	50 mm x 2" x 50 mm	460	40	1		
373 0063 06	63 mm x 2" x 63 mm	571	20	1		
373 0063 07	63 mm x 2 ½" x 63 mm	575	20	1		



Reduzier T-Stück		Klemm x Klemm x Klemm				
<i>Reducing Tee</i>		<i>compression x compression x compression</i>				
Art.-Nr. <i>Art.-No.</i>	Dimension <i>Dimension</i>	Gewicht <i>Weight</i>	VPE <i>PU</i>	UVPE <i>Bag</i>		
374A 025 20	25 mm x 20 mm x 25 mm	135	120	10		
374A 032 25	32 mm x 25 mm x 32 mm	158	80	1		
374A 040 32	40 mm x 32 mm x 40 mm	336	40	1		
374A 050 40	50 mm x 40 mm x 50 mm	497	35	1		
374A 063 50	63 mm x 50 mm x 63 mm	635	20	1		



PN 6 (POOLSCHLAUCH / POOL HOSE)

**Kupplung****Klemm x AG mit O-Ring***Adaptor**compression x male with O-ring*

Art.-Nr. Art.-No.	Dimension Dimension	Gewicht Weight	VPE PU	UVPE Bag
250 0050 05	50 mm x 1 ½ "	268	80	1
250 0050 06	50 mm x 2 "	274	70	1
250 0063 06	63 mm x 2 "	409	45	1

**Kupplung****Klemm x IG***Adaptor**compression x female*

Art.-Nr. Art.-No.	Dimension Dimension	Gewicht Weight	VPE PU	UVPE Bag
250A 050 05	50 mm x 1 ½ "	262	65	1
250A 063 06	63 mm x 2 "	313	45	1

**Kupplung****Klemm x Klebemuffe***Adaptor**compression x glued socket*

Art.-Nr. Art.-No.	Dimension Dimension	Gewicht Weight	VPE PU	UVPE Bag
250A 050 50	50 mm x 50 mm	252	75	1
250A 063 63	63 mm x 63 mm	401	45	1

**Kupplung****Klemm x Klebestutzen***Adaptor**compression x glued spigot*

Art.-Nr. Art.-No.	Dimension Dimension	Gewicht Weight	VPE PU	UVPE Bag
250 0050 50	50 mm x 50 mm	257	75	1
250 0063 63	63 mm x 63 mm	396	45	1

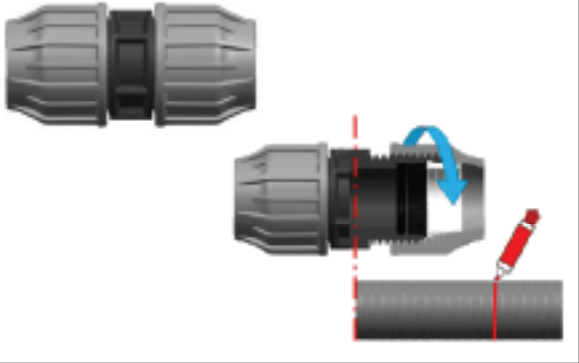
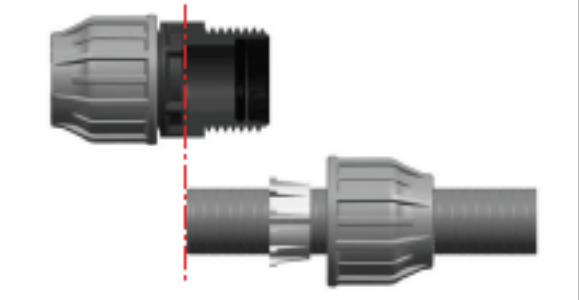
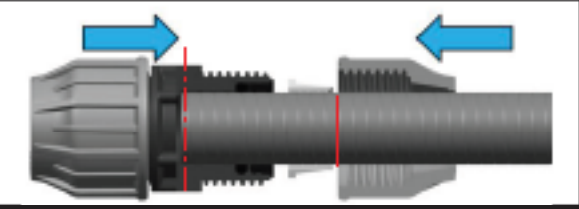
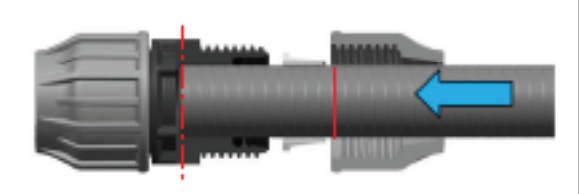
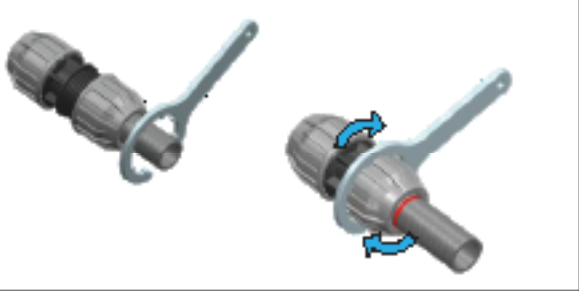
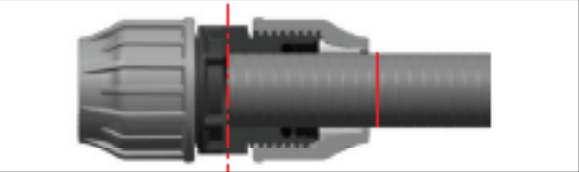

Montageanleitung

Schritt 1		<ul style="list-style-type: none"> • Die Mutter bis zum letzten Gewindegang aufdrehen, jedoch nicht entfernen. • Rohr rechtwinklig abschneiden, Grate entfernen und das Ende des Rohres mit einem Anfaswerkzeug anfasen. • Länge am PE-Rohr markieren, bis zu welcher das Rohr in den Fitting geschoben werden muss.
Schritt 2		<ul style="list-style-type: none"> • Den O-Ring in den Fittingkörper einsetzen. Die Montage fällt leichter, wenn Silikonschmiermittel auf O-Ring und Fitting Innenseite aufgetragen wird.
Schritt 3		<ul style="list-style-type: none"> • Stecken Sie das Rohr bis zum Anschlag in den Fitting.
Schritt 4		<ul style="list-style-type: none"> • Mutter und Spaltring nach vorne schieben, bis sie mit dem Fitting in Kontakt kommen.
Schritt 5		<ul style="list-style-type: none"> • Ziehen Sie die Mutter mit einem Montageschlüssel fest. (siehe Kapitel G, Seite G5)
Schritt 6		<ul style="list-style-type: none"> • Die Mutter sollte fest geschlossen sein, muss aber nicht unbedingt auf den Körper treffen.

Die Montageanleitung in Englisch erhalten Sie gerne auf Anfrage: info@elysee-rohrsysteme.com
 The assembly instructions in english is available on request: info@elysee-rohrsysteme.com



Kupplung <i>Adaptor</i>		Klemm x AG <i>compression x male</i>		
Art.-Nr. <i>Art.-No.</i>	Dimension <i>Dimension</i>	Gewicht <i>Weight</i>	VPE <i>PU</i>	UVPE <i>Bag</i>
350 0020 01	20 mm x ½ "	42	300	1
350 0025 02	25 mm x ¾ "	51	200	1
350 0032 02	32 mm x ¾ "	90	120	1
350 0032 03	32 mm x 1 "	92	120	1



Kupplung <i>Adaptor</i>		Klemm x IG <i>compression x female</i>		
Art.-Nr. <i>Art.-No.</i>	Dimension <i>Dimension</i>	Gewicht <i>Weight</i>	VPE <i>PU</i>	UVPE <i>Bag</i>
350A 020 01	20 mm x ½ "	38	300	1
350A 025 02	25 mm x ¾ "	51	200	1
350A 025 03	25 mm x 1 "	58	200	1
350A 032 02	32 mm x ¾ "	83	140	1
350A 032 03	32 mm x 1 "	85	120	1



Kupplung <i>Adaptor</i>		Klemm x Klemm <i>compression x compression</i>		
Art.-Nr. <i>Art.-No.</i>	Dimension <i>Dimension</i>	Gewicht <i>Weight</i>	VPE <i>PU</i>	UVPE <i>Bag</i>
351 0200 20	20 mm x 20 mm	70	150	1
351 0250 25	25 mm x 25 mm	91	130	1
351 0320 32	32 mm x 32 mm	145	80	1



Reduzierkupplung <i>Reducing Coupling</i>		Klemm x Klemm <i>compression x compression</i>		
Art.-Nr. <i>Art.-No.</i>	Dimension <i>Dimension</i>	Gewicht <i>Weight</i>	VPE <i>PU</i>	UVPE <i>Bag</i>
351A 025 20	25 mm x 20 mm	82	120	1
351A 032 25	32 mm x 25 mm	121	70	1



Endkappe <i>End plug</i>		Klemm <i>compression</i>		
Art.-Nr. <i>Art.-No.</i>	Dimension <i>Dimension</i>	Gewicht <i>Weight</i>	VPE <i>PU</i>	UVPE <i>Bag</i>
350B 000 20	20 mm	42	300	1
350B 000 25	25 mm	55	260	1
350B 000 32	32 mm	87	130	1



90° Winkel		Klemm x Klemm			
<i>90° Elbow</i>		<i>compression x compression</i>			
Art.-Nr. Art.-No.	Dimension Dimension	Gewicht Weight	VPE PU	UVPE Bag	
352 0200 20	20 mm x 20 mm	78	150	1	
352 0250 25	25 mm x 25 mm	98	100	1	
352 0320 32	32 mm x 32 mm	169	60	1	



90° Winkel		Klemm x AG			
<i>90° Elbow</i>		<i>compression x male</i>			
Art.-Nr. Art.-No.	Dimension Dimension	Gewicht Weight	VPE PU	UVPE Bag	
352A 020 01	20 mm x 1/2 "	46	250	1	
352A 025 02	25 mm x 3/4 "	62	150	1	
352A 032 03	32 mm x 1 "	106	100	1	



90° Winkel		Klemm x IG			
<i>90° Elbow</i>		<i>compression x female</i>			
Art.-Nr. Art.-No.	Dimension Dimension	Gewicht Weight	VPE PU	UVPE Bag	
352B 020 01	20 mm x 1/2 "	47	250	1	
352B 025 02	25 mm x 3/4 "	64	150	1	
352B 032 03	32 mm x 1 "	101	85	1	

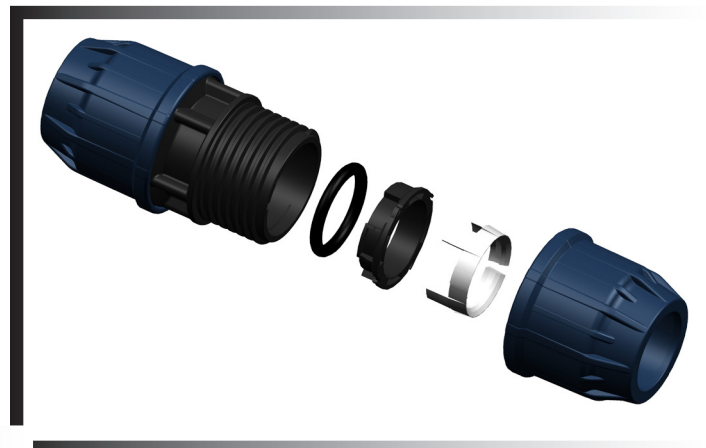



T-Stück	Klemm x IG x Klemm				
<i>Tee</i>	<i>compression x female x compression</i>				
Art.-Nr. Art.-No.	Dimension Dimension	Gewicht Weight	VPE PU	UVPE Bag	
353 0020 01	20 mm x ½" x 20 mm	91	120	1	
353 0025 02	25 mm x ¾" x 25 mm	114	80	1	
353 0032 03	32 mm x 1" x 32 mm	180	40	1	

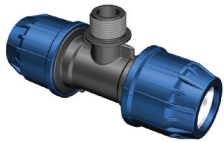

T-Stück	Klemm x AG x Klemm				
<i>Tee</i>	<i>compression x male x compression</i>				
Art.-Nr. Art.-No.	Dimension Dimension	Gewicht Weight	VPE PU	UVPE Bag	
353A 020 01	20 mm x ½" x 20 mm	82	120	1	
353A 025 02	25 mm x ¾" x 25 mm	111	75	1	
353A 032 03	32 mm x 1" x 32 mm	183	50	1	



T-Stück	Klemm x Klemm x Klemm				
<i>Tee</i>	<i>compression x compression x compression</i>				
Art.-Nr. Art.-No.	Dimension Dimension	Gewicht Weight	VPE PU	UVPE Bag	
354 0200 20	20 mm x 20 mm x 20 mm	113	100	1	
354 0250 25	25 mm x 25 mm x 25 mm	147	60	1	
354 0320 32	32 mm x 32 mm x 32 mm	242	35	1	



Reduzier T-Stück	Klemm x Klemm x Klemm				
<i>Reducing Tee</i>	<i>compression x compression x compression</i>				
Art.-Nr. Art.-No.	Dimension Dimension	Gewicht Weight	VPE PU	UVPE Bag	
354A 025 20	25 mm x 20 mm x 25 mm	136	60	1	
354A 032 25	32 mm x 25 mm x 32 mm	213	45	1	